

Operating Instructions

Air Monitoring System

Puracon Stationary PRO





TABLE OF CONTENTS

General Information and Technical Data

General Information, Description of marks and warning signs	3
Scope of Delivery	4
Technical Data	5
Unit Assembly - Display unit	6
Unit Assembly - Sensor	7

Safety Precautions

Intended Use, Operators	9
General Safety Precautions	10

Installation

Montage Aufbau Anzeigerät	12
Installation Sensor	14
Connection plan display unit	15
Electrical connection	16

Operation

Important operation instructions, Legal regulation and filling authorization	19
Start unit / Dry unit	20
Menu settings	21

Error messages	23
-----------------------------	----

Maintenance and Service

Maintenance Work	25
Maintenance Lists / Maintenance Intervals	25
Sensor maintenance / Check / Return to manufacturer	26
Check sinter filter / Replacement of the seal	27
Disposal / Electric and electronic components	28

A



GENERAL INFORMATION

General Information

We strongly recommend reading this manual thoroughly prior to operation and follow all the safety precautions precisely. Damage resulting from any deviation from these instructions is excluded from warranty and liability for this product. Carry out other commissioning steps only if you have fully understood the following contents.

Before commissioning and using the unit, carry out all the essential preliminary work and measures concerning legal regulations and safety. These are described on the following pages of this operation manual.

A

Description of marks and warning signs

The following warning signs are used in this document to identify the corresponding warning notes which require particular attention by the user. The warning signs are defined as follows:



Caution

Indicates an imminently hazardous situation which, if not avoided, could result in serious injury, physical injury or death.



Warning

Indicates a potentially hazardous situation which, if not avoided, could result in physical injury or damage to the product or environment.



Note

Indicates additional information on how to use the unit.



DESCRIPTION

Scope of Delivery

This device is used for controlling of the air/gas humidity value during the filling process of air/gas tanks by compressors with a final pressure up to 420 bar.

A

Specifications

- Aluminum sensor housing with inlet and outlet connection G $\frac{1}{4}$ "
- Display unit (120 x 120 x 60 mm) for wall mounting with sensor cable (length: 2 m)
- Power supply cable (length 1.7 m) with CE plug 24VDC and 100-/240 V AC ~ 50/60 Hz
- Digital LCD display with humidity display in mg/m³ and error warnings
- 2 monitoring LEDs, adjustable limits
- Sensor cables with 5, 10, 15 or 30 m available for surcharge
- Approved up to 350 bar
- Stainless steel sensor optional, approved up to 420 bar
- Automatic condensation (optional)
- Heater for external installation of the display unit (optional).

Available versions

- Sensor 350bar
- Sensor 420bar
- Standard plug-in power supply unit
- DIN-rail power supply unit incl. relay for emergency shutdown or automatik condensation drain
- Explosion-proof sensor with ATEX certification

DESCRIPTION

Technical Data



A

Technical Data	Display Unit
Dimensions L x W x H [mm]:	82 x 107 x 40
Installation dimensions L x W x H [mm]:	82 x 120 x 40
Weight [g]:	560 g
Power supply:	24VDC 150mA / optionally with heater 300mA
Protection Class:	IP64
Medium:	Air / NITROX up to 40% O ² / Inert gases
Relay switching capacity:	max. 30V / 300mA
Ambient Temperature [°C]:	+5 to +40 / optionally with heater -15 to +40



Technical Data	Sensor
Gas:	Compressed Air
Dimensions L x W x H [mm]:	90 x 60 x 50
Installation dimensions L x W x H [mm]:	90 x 60 x 150
Weight / basic material:	Edelstahl 1.4301 1200g / max. Druck 420 bar Aluminium AlMgSi1 450g / max Druck 350 bar
Sensor temperature range [°C]:	+5 to +45°C
Air / Gas temperature range [°C]:	+5 to +45°C
Cover screw:	M8 x 30 Steel 10.9 ISO7380 or DIN912 for 420bar M8 x 30 Stainless Steel A2 ISO7380 or DIN912 to 350bar
Filter:	50µm
Protection Class:	IP64
Type:	RSE_2012_4-20mA_Sensor

DESCRIPTION

Unit Assembly - Display unit

The display unit converts the sensor signal to a digital display value. Power supply directly with 24 VDC or by the included 100-240V switching power supply.

The LCD display shows the present humidity level in mg/m^3 and/or self-test and alarm messages.



No.	Designation
1	LCD display
2	UP - Button
3	ENTER - Button
4	DOWN - Button
5	Red - replace filter cartridge
6	Green - filter cartridge OK
7	Connection cable
8	Sensor cable

DESCRIPTION

Unit Assembly - Sensor

The sensor housing contains the highly sensitive sensor that monitors the moisture content. The housing should be mounted in the high pressure pipeline.

A

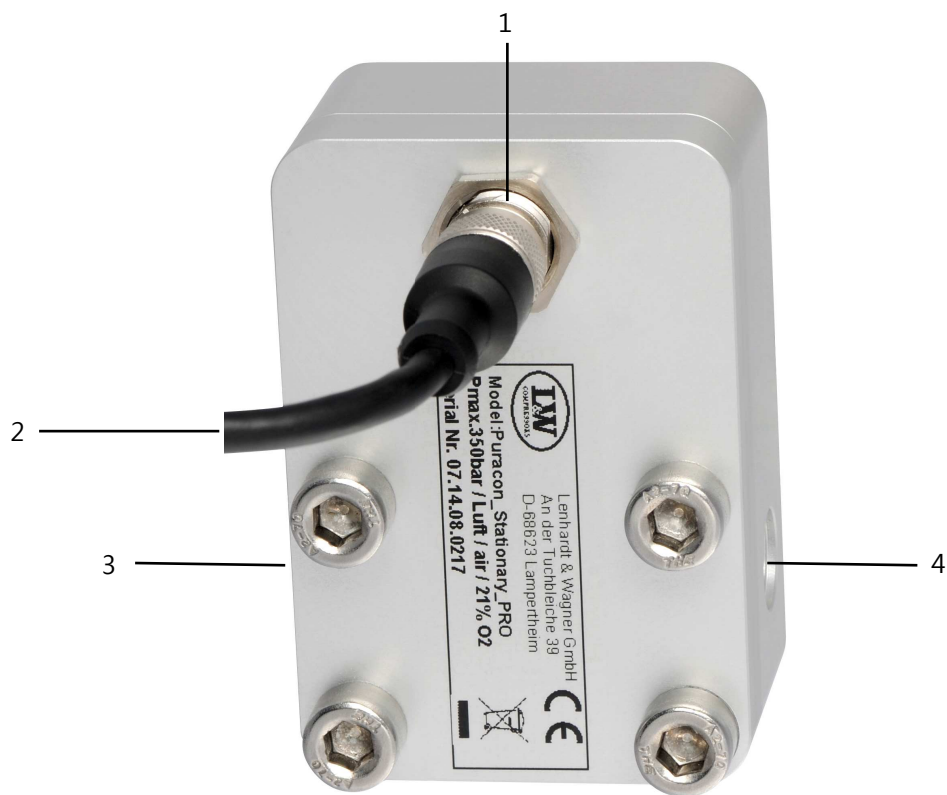

No.	Designation
1	Connection sensor cable
2	Sensor cable
3	Pipe connection
4	Pipe connection



A

SAFETY PRECAUTIONS



SAFETY PRECAUTIONS

A

Intended Use

Only use the unit in perfect condition for its intended purpose, safety and intended use and observe the operating instructions! In particular disorders that may affect safety have to be eliminated immediately!

Use the unit exclusively for the determined medium (see "Technical Data"). Any other use that is not specified is not authorized. The manufacturer/supplier shall not be liable for any damages resulting from such use. Such risk lies entirely with the user. Authorization for use is also under the condition that the instruction manual is complied with and inspection and maintenance requirements are enforced.

No change and modification to the unit can be made without the written agreement of the manufacturer. The manufacturer is not liable for damage to persons or property resulting from unauthorised modifications.

Operators

Target groups in these instructions;

Operators

Operators are persons who are authorized and briefed for the use of the compressor.

Qualified personnel

Qualified personnel are persons who are entitled to repair, service, modify and maintain the system.



Warning

Only trained personnel are permitted to work on the unit!



Warning

Work on the electrical equipment on / with the machine / unit may only be carried out by qualified electricians.



SAFETY PRECAUTIONS

Strictly follow the instruction for use

Any use of the device requires full understanding and strict observation of this instruction. The device is only to be used for purposes specified here. Also pay attention to the specific instructions for the use of compressors, filling stations and to the corresponding statutory requirements and standards.

Maintenance

The device must be inspected regularly (examination of actual condition), calibration and adjustment (compare with true values) and maintenance by competent personnel to maintain the specified condition.

Liability for proper function or damage

The liability for the proper function of this device is irrevocably transferred to the owner or operator to the extent that the device has been serviced or repaired by personnel not employed or authorized by Lenhardt & Wagner or when the device was used in a manner not conforming to its intended use.

Lenhardt & Wagner and its distribution partners cannot be held responsible for damage caused by non-compliance with the recommendations given above. The warranty and liability provision of the terms of sale and delivery of Lenhardt & Wagner and its distribution partners are likewise not modified by the recommendation given above.

Safety regulations

Inspections according to legal and local obligatory regulations regarding accident prevention are carried out by the manufacturer or by authorised expert personnel. No guarantees whatsoever are valid for damage caused or favoured by the non-consideration of these directions for use.

A



A

INSTALLATION

INSTALLATION

Display unit installation - surface-mounted

- The display unit can be mounted on a mounting plate with 4 screws M3 without opening the housing (Fig. 1, point 1).
- The housing is provided with 4 pre-punched holes to be mounted from the inside. These holes must be drilled manually (Fig. 1, point 2). In this case, the housing must be opened.
- First remove the 4 screws M3 at the front of the housing (Fig. 2).



Note

If the rubber seal is attached between upper and bottom section by vacuum (the cover cannot be removed), wait 1-2 minutes (Fig. 2).

- Remove cover and plugs (Fig. 3).
- Drill 4 mounting holes, see pre-punched holes on the rear side (Fig. 1, point 2).



Fig. 1 - Mounting holes



Fig. 2 - Cover screws

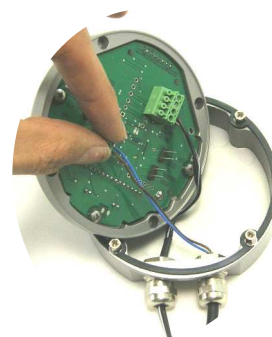

Fig. 3 - Remove plugs

- The direction of the cable outlets can be chosen freely by rotating the cover!

INSTALLATION

Display unit installation - front panel installation

A

- The cover of the display unit can also be installed into a front panel with an opening of \varnothing 63mm (standard opening of a 63mm pressure gauge).
- Drill 4 holes in the front panel, install 4 spacers M3x6mm, place sealing and mount the display on the spacers by 4 screws M3x6mm.
- Wiring on the rear side.

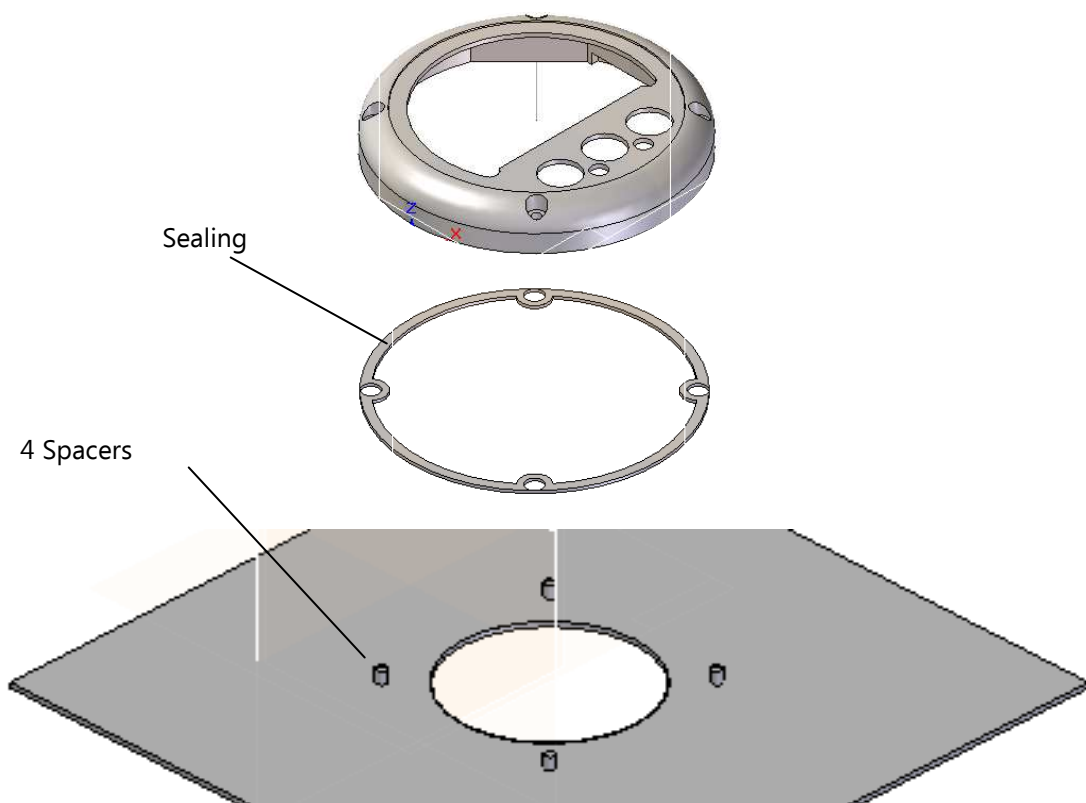

INSTALLATION

Mechanical installation



Danger

Before any work will be carried out, isolate the power supply to prevent injury and reduce the pressure in the pipes to atmospheric pressure. The installation of a non-return valve in the outlet of the sensor housing towards the filling panel may only be carried out by a qualified technician.

For installation observe the following:

- We recommend using G1/4" Ermeto connections.
- Before mounting the housing, tighten the screws again (Fig. 2).
Attention: Screw depth max. 4 mm!
- Mount the sensor tightly at a place with low vibration. Mount the sensor at least by two M8 mounting screws.
An installation only by gas lines is not allowed!



Fig. 1 - G1/4" Ermeto connection

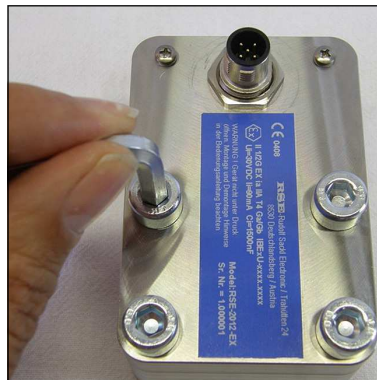

Fig. 2 - Retighten cover screws



Fig. 3 - Rear sided opening M8

INSTALLATION

Connection plan display unit



Hinweis

The alarm output 2 is not isolated!

Maximum power: Power supply: 40mA / power supply: 100mA

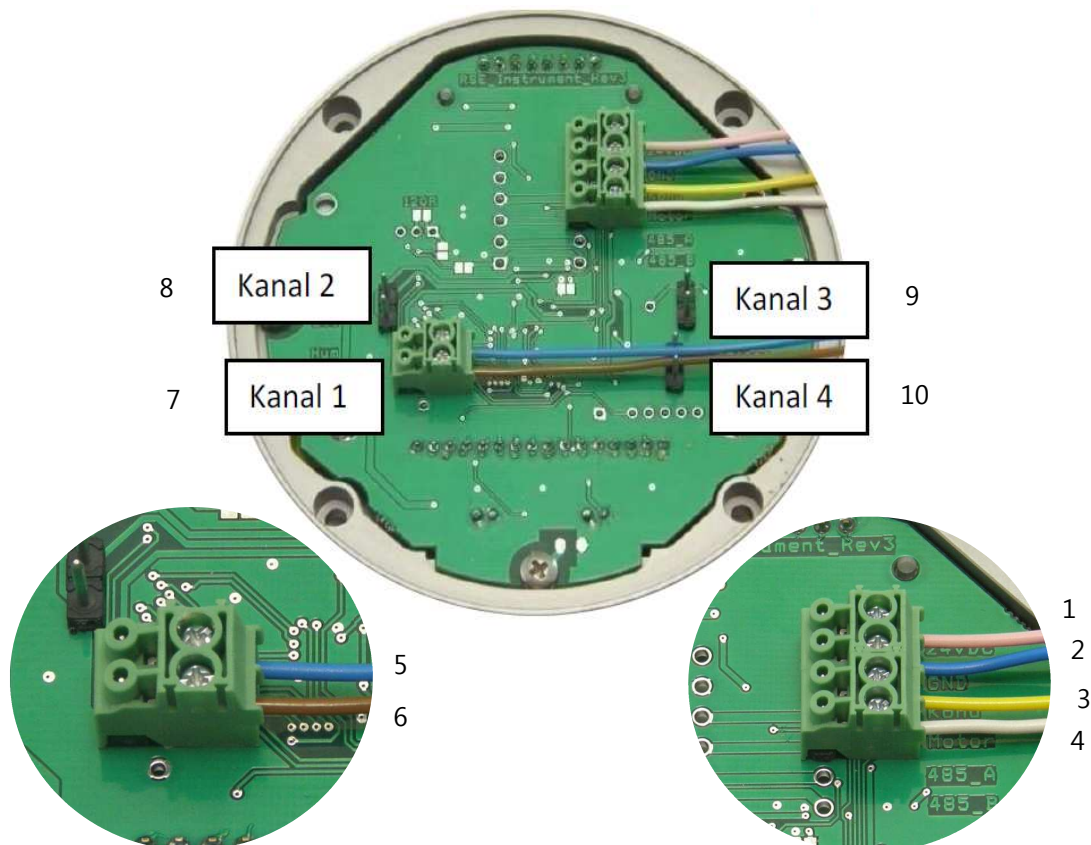

No.	Designation
1	24VDC positive terminal (pink)
2	0 GND (blue)
3	Switching output optional automatic condensation (yellow)
4	Alarm switching output for motor emergency stop (white)
5	Sensor signal input (blue)
6	Sensor 24VDC supply (brown)
7	Kanal 1: 4-20mA input (100R) signal blue) 24V (brown)
8	Kanal 2: not assigned
9	Kanal 3: not assigned
10	Kanal 4: not assigned

INSTALLATION

Electrical connection

- Connect sensor cable (Fig. 1)
Attention: The gas lines must be connected to earth.
- Connect power supply: 240 VAC - connect the plug to socket.

Compressor shutdown (optional)

If the humidity value is too high (red LED) the compressor will be switched off.

Semiconductor output for max. 24VDC-300mA.

Automatic condensation (optional)

The condensate valve is controlled automatically.

Semiconductor output for max. 24VDC-300mA.

For any questions about options, please contact us.

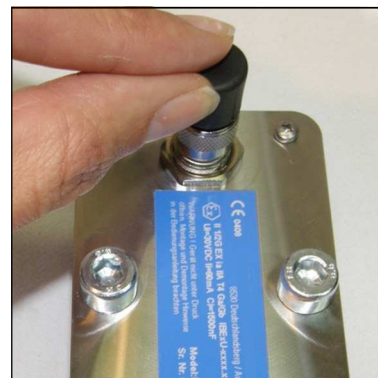

Fig. 1 - Connect sensor cable



Note

The unit must be earthed to avoid electromagnetic interference!

Use the earthed gas line (a shielded sensor cable must be used) or mount the rear side of the housing with the openings M3 on an earthed mounting plate (e.g. filling panel).

INSTALLATION

Electrical connection when using external relays



Caution

The unit is designed for a maximum voltage of 28VDC-300mA.
Caution! Never connect the unit to 230VAC.

- Remove plug-in power supply and cable.



- Connect a 3-pole cable (min. 3x0,25mm², max. length 10m).
- Connect power supply and the required relay (Optional).

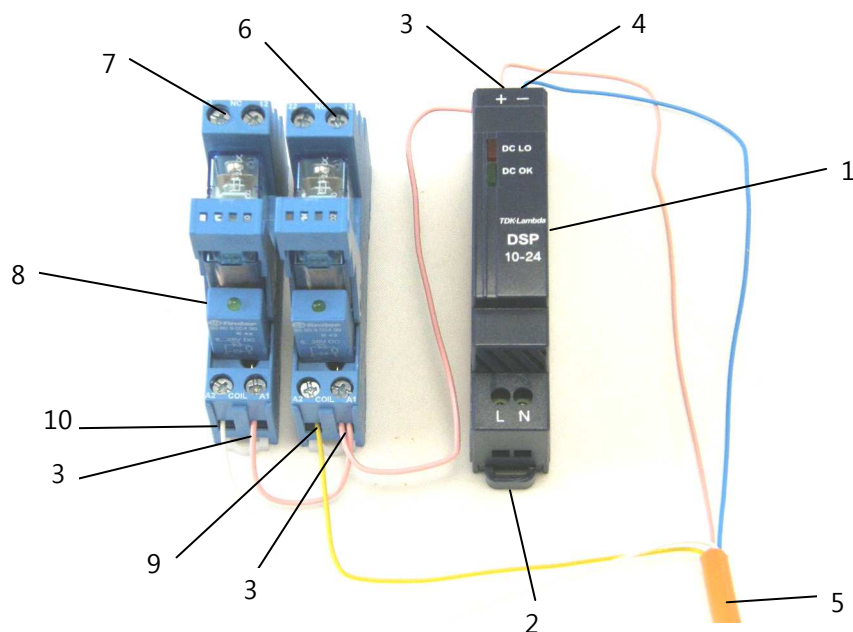

No.	Designation
1	DSP-10-24 DIN switching power supply 10Watt, 24VDC, 300mA
2	100-240VAC input
3	+24VDC 300mA output (pink)
4	0V ground output (blue)
5	4-pole display unit cable
6	Condensate relay (switching capacity 10A 300VAC)
7	Alarm or motor relay (switching capacity 10A 300VAC) + Signal lamp max..24V / 100mA
8	Signal LED with protective diode (CAUTION ! Always operate the relay with protective diode)
9	Switching line of the display unit for automatic condensation (yellow)
10	Switching line of the display unit for the alarm or motor relay (white)



A

OPERATION



OPERATION

Important operation instructions

- Each contamination and humidity values higher than 60 mg/m^3 can influence the measurement or/ and damage the sensor. Ensure a clean pipe line system.
- Before mounting, the pipes must be cleaned from contamination to avoid damage of the sensor. Every contamination can reduce the measured values or damage the sensor. Each excessive pressure and temperature changes can produce condensate.
- Humidity values higher than 60 mg/m^3 can reduce the sensor lifetime.
- High pressure and temperature changes provoke high humidity fluctuation. Too high system humidity tends to condensate.
- Consistent measurement or sensor protection from condensation as follows:
 - avoid gas flow returning into the pipe system
 - do not exceed the maximum humidity value of 25 mg/m^3 (orange LED) according to EN12021 (2012)
 - prevent the sensor from frequent, abrupt pressure changes..
- **WARNING!** Correct humidity values are only possible during gas flow and with a working pressure from 200 to 300 bar.

A

OPERATION

A

Start

During commissioning of the display unit, all LEDs light up and the display indicates the unit and software version and the current humidity value.

- Red - replace filter cartridge (Grenzwert 25mg/m³)
- Green - filter cartridge OK



Note

After longer standstill of the compressor or after filter change, the yellow or red LED may be illuminated and the digital display may indicate a humidity value higher than 25 mg/m³. This is caused by the remaining humidity in the pipes or by the delayed effect of new filters.

Dry unit - only necessary with the option "Compressor- shutdown"

Only necessary for installations with auto shutdown of the compressor when the red LED is illuminated.

During drying, the compressor operation will be released for 10 minutes regardless of the humidity value.

To rinse the system without auto shutdown of the compressor, carry out the drying process.

Drying process as follows:



ENT

The unit must show the humidity value (normal operation), press and hold ENTER button for 3 sec.



The display shows "DELAY" and the LEDs flash during 10 minutes DELAY time.



OPERATION



A

Menu settings

Menu settings change as follows:



 Reset and restart the unit by pressing the UP and DOWN buttons simultaneously and press and hold the ENTER button immediately afterwards

 Hold the ENTER button as long as MENU will be displayed.
 



 Mit der UP und DOWN Taste wird der gewünschte Menu-Punkt ausgewählt.

Maximum limit value setting (preset 26mg/m³)



Minimum limit value setting (preset -3mg/m³) This limit value is deactivated because the sensor will never generate values below 0 mg/m³.



Programming Optional function



Customising Optional function

DELAY ON - activates automatic drying during unit start-up. Preset drying time = 10 minutes. Drying time adjustment by the buttons UP and DOWN

DELAY OFF - deactivates automatic drying.

 Select the desired menu item by the ENTER button.



 Select the desired value by the UP and DOWN buttons.

 Save the selected value by the ENTER button



A

ERROR MESSAGES

ERROR MESSAGES

Error display

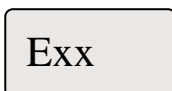

Error messages treatment as follows:

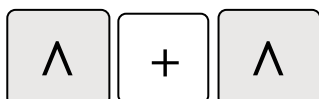

Reset and restart the unit by pressing the UP and DOWN buttons simultaneously.

Code	Cause	Remedy
ERROR 1	undefined software error	back to manufacturer
ERROR 2	no sensor signal	check cable connections
ERROR 3	more than one sensor connected	connect only one sensor
ERROR 4	not used	
ERROR 5	not used	
ERROR 10 ERROR 11	internal voltage reference defective	back to manufacturer
ERROR 12	supply voltage too low; 20-28VDC required	supply cable - use a higher cross section or a stronger power unit.
ERROR 13	internal overcurrent protection defective	back to manufacturer
ERROR 14-17	sensor cable short-circuit	check sensor cable
ERROR 18	sensor voltage too low	check sensor cable
ERROR 21	internal hardware error	back to manufacturer



A

MAINTENANCE AND SERVICE

MAINTENANCE AND SERVICE

A

Maintenance Work

Carry out service and maintenance work exclusively when the compressor is stopped and depressurized. The unit should be leak-checked regularly. Leaks can be preferably localised by using a leak detector spray (if necessary, brush pipes with soapy water).

We urgently recommend that all maintenance, repair and installation work must only be carried out by trained personnel. This is necessary because all maintenance work can not be explained exactly and detailed in this manual.

Only use authentic spare parts for service work.

 **Danger**
 Components under pressure, such as the hose ends, can quickly come loose when manipulated and can cause potentially fatal injuries due to the pressure surge.
 Any work on system parts may only be performed in a pressure-compensated state.

 **Warning**
 The use of accessories that have not been tested can lead to death or serious injury or damage to the unit. Only use authentic spare parts for service work.

 **Warning**
 Carry out maintenance or service work when the unit is switched off and protected against unexpected restart.

Carry out the following maintenance work every 12 months

Maintenance type	Quantity	Order. No.
Visual control for contamination or damage of the sinter filter. Change the sinter filter and the O-ring if necessary.	1	007318
Sensor check	-	-

MAINTENANCE AND SERVICE

A

Sensor maintenance / check

 **Danger**
Do not open when the gas lines are pressurized!

Sensor maintenance / check as follows:

- Loosen cover screws, do not extract.
- Lift cover at least 1 cm
- The humidity value should increase fast up to at least 25 mg/m³. If the humidity value should not increase, return sensor, display unit and cables to the manufacturer for check / repair / calibration!
- Place cover
- Place and mount screws crosswise

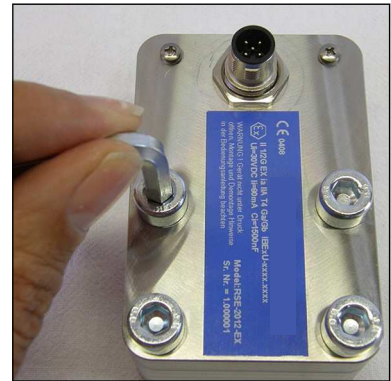

Loosen cover screws, do not extract

The sensor maintenance / check is now completed.

Return to manufacturer

Please return sensor, display unit, all cables as well as a short error description to the manufacturer. A free software update and a cleaning will be carried out during check / repair / calibration.

Calibration

Return only the sensor for calibration.

 **Note**
For return delivery to manufacturer ensure sufficient sensor protection.

 **Note**
To continue the compressor operation after removing the sensor you can order the connection piece with the order number: 007323

MAINTENANCE AND SERVICE

Check sinter filter / replacement of the seal



Danger

Do not open when the gas lines are pressurized!



Warning

Do not touch or contaminate the sensor. Each contamination can influence the measurement or/and damage the sensor.

Sinter filter or seal check as follows:

- Switch unit off.
- Loosen and extract cover screws 4 x M8.
- Remove sensor housing top and place it on a clean surface. Attention: Do not touch or contaminate the sensor.
- Unscrew the sinter filter out of the sensor housing and check it (visual inspection). Replace a damaged or contaminated sinter filter immediately (seal kit Puracon: 007318).
- Replace the seal.
- Place sensor housing top and tighten cover screws.



Fig. 1 - Loosen cover screws

The sinter filter or seal check is now completed.



Fig. 2 - Sensor housing top and bottom

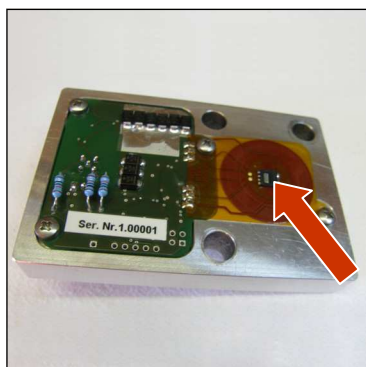

Fig. 3 - Sensor



Fig. 4 - Rear cover, seal and sinter filter

DISPOSAL

Disposal

The product must be disposed in accordance with national waste disposal regulations and by an appropriate waste disposal company.

A

Electric and electronic components

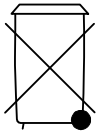

EU-wide regulations for the disposal of electric and electronic appliances which have been defined in the EU Directive 2002/96/EC and in national laws are effective from August 2005 and apply to this device.

Common household appliances can be disposed by using special collecting and recycling facilities. However, as this device has not been registered for household usage, it must not be disposed of through these means.

The device can be returned to L&W. Please do not hesitate to contact us if you have any further questions on this issue.